





Vehicle History Report™

US \$44.99

2016 NISSAN ROGUE SL

VIN: 5N1AT2MV6GC772343
4 DOOR WAGON/SPORT UTILITY
2.5L I4 F DOHC 16V GASOLINE
ALL WHEEL DRIVE
Original Window Sticker

Accident reported: moderate damage





MINOR MODERATE SEVERE

 **12** Service history records

 At least 1 open recall

 **5** Previous owners

 **67,729** Last reported odometer reading

This CARFAX Vehicle History Report is based only on information supplied to CARFAX and available as of 11/21/24 at 4:07:38 PM (CST). Other information about this vehicle, including problems, may not have been reported to CARFAX. Use this report as one important tool, along with a vehicle inspection and test drive, to make a better decision about your next used car.



Accident / Damage History

Not all accidents / issues are reported to CARFAX

Event 1

08/23/2019

Accident reported: moderate damage with another motor vehicle

Damage Severity Scale



MINOR MODERATE SEVERE

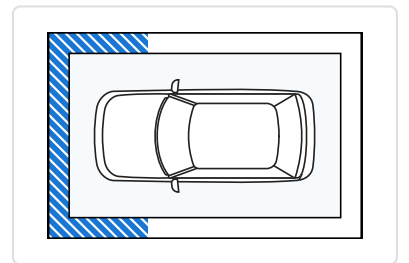

Event 2

06/26/2022

Accident reported: moderate damage

- Vehicle involved in a sideswipe collision with another motor vehicle

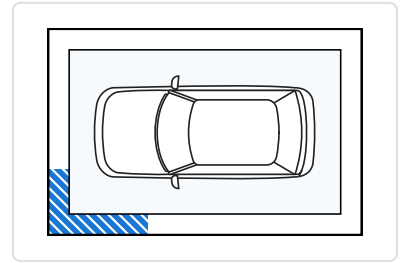
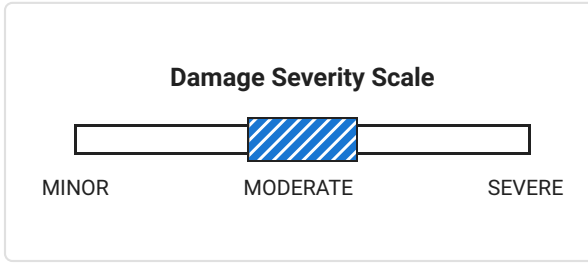

Event 3

06/26/2022

Damage reported: minor damage

- Accident damage claim reported
 - Claim amount was CAD\$10,647
 - Claim amount was updated on 10/15/2022.

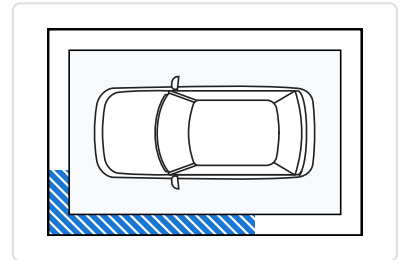
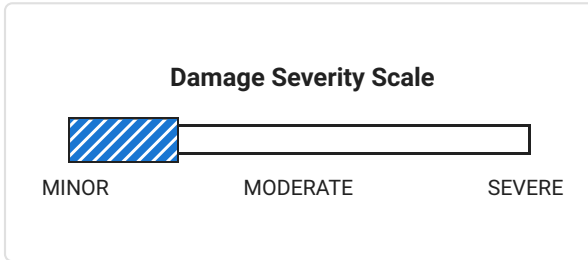

Event 4

07/23/2024

Damage reported: minor damage

- Accident damage claim reported
 - Claim amount was CAD\$7,992
 - Claim amount was updated on 11/02/2024.

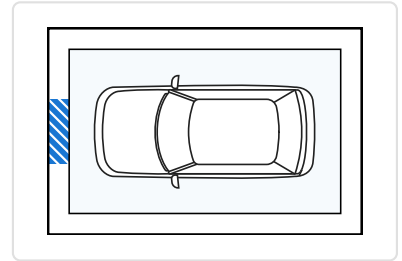
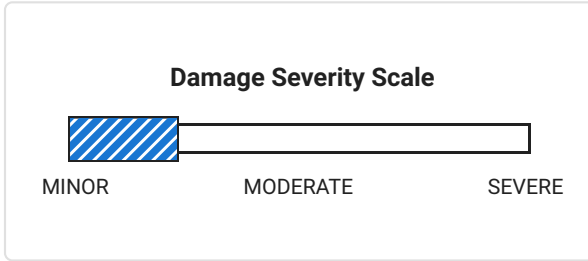

Additional History

Not all accidents / issues are reported to CARFAX

Owners 1-3

Owner 4

Owner 5

Total Loss No total loss reported to CARFAX.	<input checked="" type="checkbox"/> No Issues Reported	<input checked="" type="checkbox"/> No Issues Reported	<input checked="" type="checkbox"/> No Issues Reported
Structural Damage CARFAX recommends that you have this vehicle inspected by a collision repair specialist.	<input checked="" type="checkbox"/> No Issues Reported	<input checked="" type="checkbox"/> No Issues Reported	<input checked="" type="checkbox"/> No Issues Reported
Airbag Deployment No airbag deployment reported to CARFAX.	<input checked="" type="checkbox"/> No Issues Reported	<input checked="" type="checkbox"/> No Issues Reported	<input checked="" type="checkbox"/> No Issues Reported
Odometer Check No indication of an odometer rollback.	<input checked="" type="checkbox"/> No Issues Indicated	<input checked="" type="checkbox"/> No Issues Indicated	<input checked="" type="checkbox"/> No Issues Indicated
Accident / Damage Accidents reported: 08/23/2019, 06/26/2022, and 07/23/2024.	Accident Reported	No New Issues Reported	Accident Reported
Manufacturer Recall At least 1 manufacturer recall requires service. Locate an authorized Nissan dealer near you to schedule an appointment.	<input checked="" type="checkbox"/> No Recalls Reported	<input checked="" type="checkbox"/> No Recalls Reported	Recall Reported
Basic Warranty Original warranty estimated to have expired.	Warranty Expired	Warranty Expired	Warranty Expired

 Title History CARFAX guarantees the information in this section	Owners 1-3	Owner 4	Owner 5
Damage Brands Salvage Junk Rebuilt Fire Flood Hail Lemon	<input checked="" type="checkbox"/> Guaranteed No Problem	<input checked="" type="checkbox"/> Guaranteed No Problem	<input checked="" type="checkbox"/> Guaranteed No Problem
Odometer Brands Not Actual Mileage Exceeds Mechanical Limits	<input checked="" type="checkbox"/> Guaranteed No Problem	<input checked="" type="checkbox"/> Guaranteed No Problem	<input checked="" type="checkbox"/> Guaranteed No Problem







GUARANTEED - None of these title problems were reported by a U.S. state Department of Motor Vehicles (DMV). If you find that any of these title problems were reported by a DMV and not included in this report, you may qualify. [View Terms](#) | [View Certificate](#)



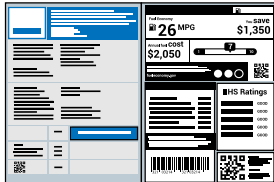

 Ownership History The number of owners is estimated	Owners 1-3	Owner 4	Owner 5
Year purchased	2016	2021	2021





Type of owner	Personal	Personal	Personal
Estimated length of ownership	5 yrs. 2 mo.	5 months	3 yrs. 1 mo.
Owned in the following states/provinces	See Details	Ontario	Ontario
Estimated miles driven per year	See Details	---	---
Last reported odometer reading	60,290	60,896	67,729

CARFAX Detailed History

 **Owner 1**
 Purchased: 2016 Personal Vehicle
17,326 mi/yr

Date	Mileage	Source	Comments
11/21/2015		Nissan North America, Inc.	Vehicle manufactured and shipped to original dealer  Original Window Sticker
03/10/2016		Ontario Ministry of Transportation	Registration issued or renewed - First owner reported - Registered as personal vehicle - Passed safety inspection - Vehicle color noted as Gray
12/16/2016		Krown Kingston Kingston, ON 613-549-7878 https://krown.com/canada/ontario/kingston/kingston/  5.0 / 5.0 11 Verified Reviews  6 Customer Favorites	 Vehicle serviced - Undercoating/rustproofing applied
04/07/2017	21,747	Ontario	Odometer reading reported

		Ministry of Transportation		- Odometer reported as 34,998 kilometers
04/09/2017		Ontario Ministry of Transportation		Registration issued or renewed - Registered as personal vehicle
08/18/2017		Krown Kingston Kingston, ON 613-549-7878 https://krown.com/canada/ontario/kingston/kingston/ ★ 5.0 / 5.0 11 Verified Reviews ❤️ 6 Customer Favorites		Vehicle serviced - Undercoating/rustproofing applied
01/08/2018	37,776	James Braden Nissan Kingston, ON 833-579-3341 jamesbradennissan.ca/		Vehicle serviced - Maintenance inspection completed - Oil and filter changed - Odometer reported as 60,795 kilometers
04/20/2018	40,389	Ontario Ministry of Transportation		Registration issued or renewed - Registered as personal vehicle - Odometer reported as 65,000 kilometers
05/24/2018	43,039	James Braden Nissan Kingston, ON 833-579-3341 jamesbradennissan.ca/		Vehicle serviced - Maintenance inspection completed - Oil and filter changed - Odometer reported as 69,265 kilometers
06/22/2018	44,314	James Braden Nissan Kingston, ON 833-579-3341 jamesbradennissan.ca/		Vehicle serviced - Maintenance inspection completed - Odometer reported as 71,316 kilometers
09/10/2018		Krown Kingston Kingston, ON 613-549-7878 https://krown.com/canada/ontario/kingston/kingston/ ★ 5.0 / 5.0 11 Verified Reviews ❤️ 6 Customer Favorites		Vehicle serviced - Undercoating/rustproofing applied

10/11/2018	48,156	James Braden Nissan Kingston, ON 833-579-3341 jamesbradennissan.ca/		Vehicle serviced - Maintenance inspection completed - Oil and filter changed - Odometer reported as 77,500 kilometers
11/06/2018	49,034	Ajax Nissan Ajax, ON 905-686-0555 ajaxnissan.com/ ★ 3.5 / 5.0 11 Verified Reviews ♥ 7 Customer Favorites		Vehicle serviced - Front brakes serviced - Oil and filter changed - Rear brake pads replaced - Rear brake rotor(s) replaced - Vehicle washed/detailed - Odometer reported as 78,913 kilometers
12/14/2018		Ajax Nissan Ajax, ON 905-686-0555 ajaxnissan.com/ ★ 3.5 / 5.0 11 Verified Reviews ♥ 7 Customer Favorites		Vehicle serviced - Pre-delivery inspection completed - Vehicle washed/detailed - Four tires balanced - Four tires mounted - Window tint installed
04/29/2019	54,260	Willowdale Nissan Thornhill, ON 905-881-3900 willowdalenissan.com/ ★ 4.7 / 5.0 11 Verified Reviews ♥ 2 Customer Favorites		Vehicle serviced - Drive belts checked - Air filter checked - Fluids checked - Oil and filter changed - Tire condition and pressure checked - Wipers/washers checked - Odometer reported as 87,323 kilometers
05/14/2019	55,065	Willowdale Nissan Thornhill, ON 905-881-3900 willowdalenissan.com/ ★ 4.7 / 5.0 11 Verified Reviews ♥ 2 Customer Favorites		Vehicle serviced - Odometer reported as 88,619 kilometers

 Owner 2 Purchased: 2019	Personal Vehicle
---	------------------

Date	Mileage	Source	Comments
05/15/2019	55,115	Ontario	Registration issued or renewed

05/15/2019 55,115

Ontario
Ministry of
Transportation

Registration issued or renewed

- New owner reported
- Registered as personal vehicle
- Odometer reported as 88,699 kilometers

08/17/2019 59,706

Great Canadian Oil
Change
Scarborough, ON
416-757-7817
gcoc.ca



Vehicle serviced

- Air filter checked
- Oil and filter changed
- Fluids checked
- Odometer reported as 96,087 kilometers

08/23/2019

Ontario
Damage Report



Accident reported: moderate damage with another motor vehicle

- Damage to front
- Damage to left front
- Damage to right front



**CARFAX HAS THE MOST
ACCIDENT & DAMAGE
INFORMATION**

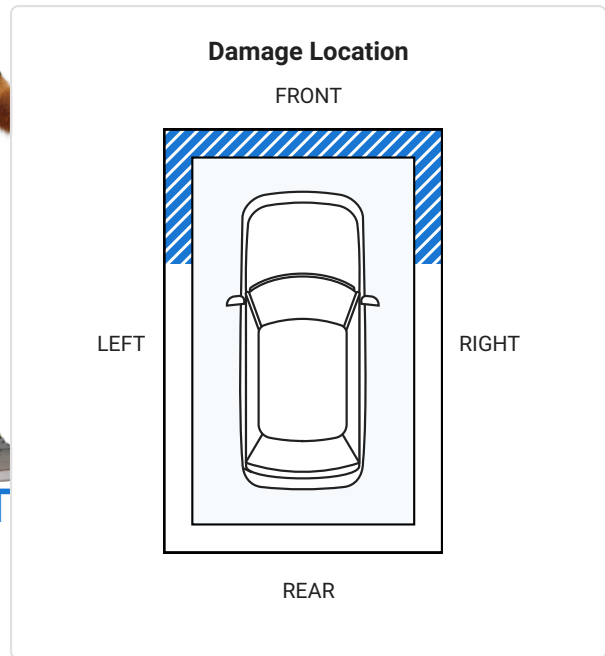
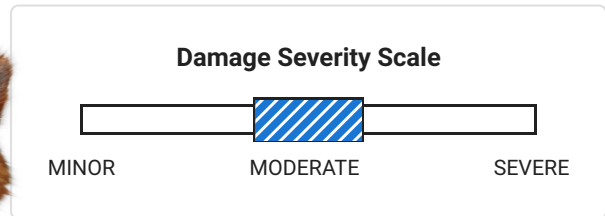

Safety first! In accidents like this, airbags may deploy and need replacing. Get them inspected before you buy. Airbag Tips

 **Owner 3**
Purchased:
2019

Personal Vehicle

Date	Mileage	Source	Comments
12/03/2019		Ontario Ministry of Transportation	Passed Ontario safety standards inspection - New owner reported - Vehicle color noted as Gray
01/09/2021	60,290	Ontario Ministry of Transportation	Registration issued or renewed - Registered as personal vehicle - Vehicle color noted as Gray - Odometer reported as 97,027 kilometers

 **Owner 4**
Purchased:
2021

Personal Vehicle

Date	Mileage	Source	Comments
05/17/2021		Ontario Ministry of Transportation	Passed Ontario safety standards inspection - New owner reported - Vehicle color noted as Gray
07/30/2021	60,896	Ontario Ministry of Transportation	Registration issued or renewed - Registered as personal vehicle - Vehicle color noted as Gray - Odometer reported as 98,003 kilometers

 **Owner 5**
Purchased:
2021

Personal Vehicle

Date	Mileage	Source	Comments
10/18/2021		Ontario Ministry of Transportation	Passed Ontario safety standards inspection - New owner reported - Vehicle color noted as Gray
01/25/2022		Nissan Canada, Inc.	Manufacturer Safety recall issued - Recall #R21B9 VSRC 2014-2016 ROGUE; DASH SIDE HARNESS

Locate an authorized Nissan dealer near you to obtain more information about this recall

[⊕ Learn more about this recall](#)

06/26/2022

Ontario
Damage Report



Accident reported: moderate damage

- Vehicle involved in a sideswipe collision with another motor vehicle
- Damage to left front



CARFAX HAS THE MOST ACCIDENT & DAMAGE INFORMATION

Damage Severity Scale



Damage Location

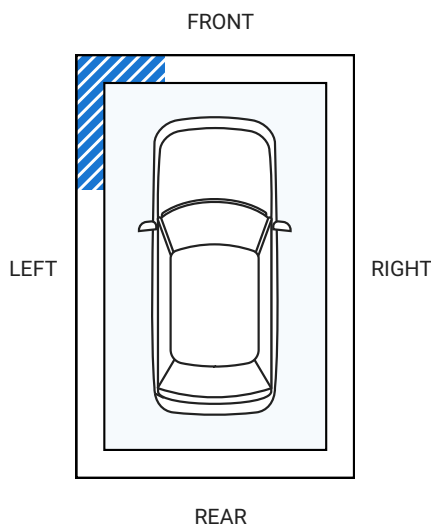

06/26/2022

Damage Report
Ontario



Damage reported: minor damage

- Damage to left front
- Damage to left side
- Accident damage claim reported
- Claim amount was CAD\$10,647
- Claim amount was updated on 10/15/2022.



Damage Severity Scale

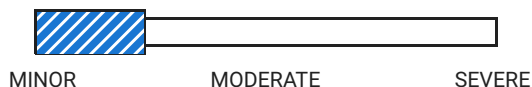



CARFAX HAS THE MOST ACCIDENT & DAMAGE INFORMATION

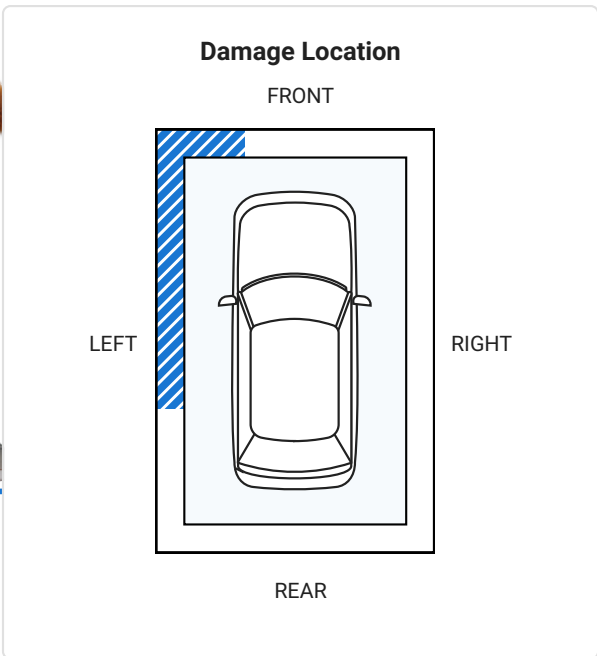

08/11/2022 67,729

Ontario
Ministry of
Transportation

Registration issued or renewed

- Registered as personal vehicle
- Vehicle color noted as Gray
- Odometer reported as 108,999 kilometers

07/23/2024

Damage Report
Ontario



Damage reported: minor damage

- Damage to front
- Accident damage claim reported
- Claim amount was CAD\$7,992
- Claim amount was updated on 11/02/2024.

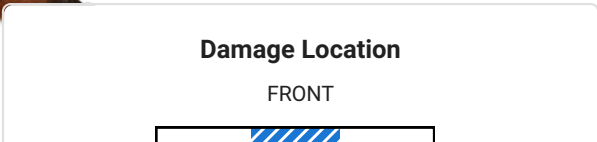
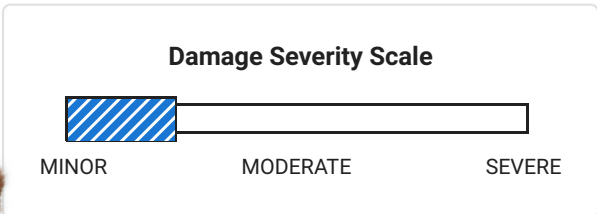



CARFAX HAS THE MOST ACCIDENT & DAMAGE INFORMATION

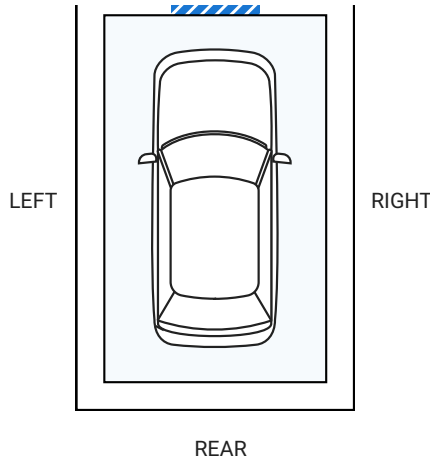

07/30/2024

Ontario
Ministry of
Transportation

Registration issued or renewed
- Registered as personal vehicle

Have Questions? Consumers, please visit our Help Center at www.carfax.com. Dealers or Subscribers, please visit our Help Center at www.carfaxonline.com.



Glossary

Accident Indicator

CARFAX receives information about accidents in all 50 states, the District of Columbia and Canada.

Not every accident is reported to CARFAX. As details about the accident become available, those additional details are added to the CARFAX Vehicle History Report. CARFAX recommends that you have this vehicle inspected by a qualified mechanic.

- According to the National Safety Council, Injury Facts, 2021 edition, 5% of the 276 million registered vehicles in the U.S. were involved in an accident in 2019. Over 77% of these were considered minor or moderate.
- This CARFAX Vehicle History Report is based only on information supplied to CARFAX and available as of 11/21/24 at 4:07:38 PM (CST). Other information about this vehicle, including problems, may not have been reported to CARFAX. Use this report as one important tool, along with a vehicle inspection and test drive, to make a better decision about your next used car.

Canadian Damage Report

CARFAX receives damage reports for many accidents occurring in the following Canadian Provinces: Ontario, Alberta, Nova Scotia, New Brunswick, Prince Edward Island, Newfoundland, Yukon territories, Northwest territories, and Nunavut. These reports may be completed following an accident or other incident. Some include a damage claim amount. This amount represents physical damage to the vehicle and depending on the accident, damage to other vehicles and/or property. It does not include expenses like towing, a rental car or any medical related items.

Damage Indicator

Damage can be a result of many different types of events. Examples include contact with objects (other cars, trees, traffic signs, road debris, etc), vandalism, or weather-related events. Not every damage event is reported to

CARFAX. As details about the damage event become available, those additional details are added to the CARFAX Vehicle History Report. CARFAX recommends that you have this vehicle inspected by a qualified mechanic.

- This CARFAX Vehicle History Report is based only on information supplied to CARFAX and available as of 11/21/24 at 4:07:38 PM (CST). Other information about this vehicle, including problems, may not have been reported to CARFAX. Use this report as one important tool, along with a vehicle inspection and test drive, to make a better decision about your next used car.

Damage Severity

Damage events result in one of the following severity levels:

- **Minor:** Generally, minor damage is cosmetic (including dents or scratches), may only require reconditioning, and typically does not compromise a vehicle's operation and/or safety.
- **Moderate:** Moderate damage may affect multiple components of the vehicle and may impair the vehicle's operation and/or safety.
- **Severe:** Severe damage usually affects multiple components of the vehicle and is likely to compromise the vehicle's operation and/or safety.

CARFAX recommends getting a pre-purchase inspection at a certified collision repair facility.

First Owner

When the first owner(s) obtains a title from a Department of Motor Vehicles as proof of ownership.

Manufacturer Recall



Automobile manufacturers issue recall notices to inform vehicle owners of a safety defect or failure to meet minimum federal safety or emissions standards. Manufacturer recalls are repaired at no cost to the customer.

New Owner Reported

When a vehicle is sold to a new owner, the Title must be transferred to the new owner(s) at a Department of Motor Vehicles.

Ownership History

CARFAX defines an owner as an individual or business that possesses and uses a vehicle. Not all title transactions represent changes in ownership. To provide estimated number of owners, CARFAX proprietary technology analyzes all the events in a vehicle history. Estimated ownership is available for vehicles manufactured after 1991 and titled solely in the US including Puerto Rico. Dealers sometimes opt to take ownership of a vehicle and are required to in the following states: Maine, Massachusetts, New Jersey, Ohio, Oklahoma, Pennsylvania and South Dakota. Please consider this as you review a vehicle's estimated ownership history.

Follow Us:  [facebook.com/CARFAX](https://www.facebook.com/CARFAX)  [@CARFAXinc](https://twitter.com/CARFAXinc)  **About CARFAX**

CARFAX DEPENDS ON ITS SOURCES FOR THE ACCURACY AND RELIABILITY OF ITS INFORMATION. THEREFORE, NO RESPONSIBILITY IS ASSUMED BY CARFAX OR ITS AGENTS FOR ERRORS OR OMISSIONS IN THIS REPORT. CARFAX FURTHER EXPRESSLY DISCLAIMS ALL WARRANTIES, EXPRESS OR IMPLIED, INCLUDING ANY IMPLIED WARRANTIES OF MERCHANTABILITY OR FITNESS FOR A PARTICULAR PURPOSE.

© 2024 CARFAX, Inc., part of S&P Global. All rights reserved.
11/21/24 4:07:38 PM (CST)

I have reviewed and received a copy of the CARFAX Vehicle History Report for this 2016 NISSAN ROGUE vehicle (VIN: 5N1AT2MV6GC772343), which is based on information supplied to CARFAX and available as of 11/21/24 at 5:07 PM (EST).

Customer Signature

Date

Dealer Signature

Date