





Vehicle History Report™

US \$44.99

2014 CHRYSLER TOWN AND COUNTRY TOURING-L

VIN: 2C4RC1CGXER118258
 VAN
 3.6L V6 F DOHC 24V
 GASOLINE
 FRONT WHEEL DRIVE
 Original Window Sticker

Accident reported: moderate damage

MINOR MODERATE SEVERE

 **25** Service history records

 **42** Detailed records available

This CARFAX Vehicle History Report is based only on information supplied to CARFAX and available as of 4/17/25 at 5:00:03 PM (CDT). Other information about this vehicle, including problems, may not have been reported to CARFAX. Use this report as one important tool, along with a vehicle inspection and test drive, to make a better decision about your next used car.

CARFAX Accident / Damage History

Not all accidents / issues are reported to CARFAX

Event 1

06/22/2014
Accident reported: moderate damage
 - It hit an object

Damage Severity Scale



MINOR MODERATE SEVERE

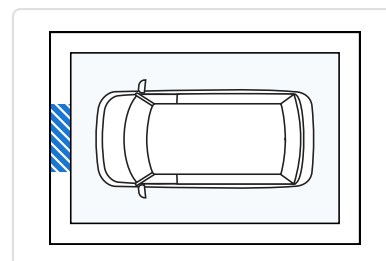

CARFAX Additional History

Not all accidents / issues are reported to CARFAX

Summary

Total Loss
 No total loss reported to CARFAX.

 **No Issues Reported**

<p>Structural Damage CARFAX recommends that you have this vehicle inspected by a collision repair specialist.</p>	<p><input checked="" type="checkbox"/> No Issues Reported</p>
<p>Airbag Deployment No airbag deployment reported to CARFAX.</p>	<p><input checked="" type="checkbox"/> No Issues Reported</p>
<p>Odometer Check Inconsistent mileage indicated.</p>	<p>Mileage Inconsistency</p>
<p>Accident / Damage Accident reported: 06/22/2014.</p>	<p>Accident Reported</p>
<p>Manufacturer Recall No open recalls reported to CARFAX.</p>	<p><input checked="" type="checkbox"/> No Recalls Reported</p>
<p>Basic Warranty Original warranty estimated to have expired.</p>	<p>Warranty Expired</p>

<p>CARFAX Title History CARFAX guarantees the information in this section</p>	<p>Summary</p>
<p>Damage Brands Salvage Junk Rebuilt Fire Flood Hail Lemon</p>	<p><input checked="" type="checkbox"/> Guaranteed No Problem</p>
<p>Odometer Brands Not Actual Mileage Exceeds Mechanical Limits</p>	<p><input checked="" type="checkbox"/> Guaranteed No Problem</p>
<p> GUARANTEED - None of these title problems were reported by a U.S. state Department of Motor Vehicles (DMV). If you find that any of these title problems were reported by a DMV and not included in this report, you may qualify. View Terms View Certificate</p>	

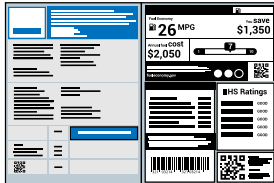
<p>CARFAX Detailed History</p>			
Date	Mileage	Source	Comments
Not Reported		FCA	<p>Vehicle manufactured and shipped to original dealer</p> 

Original Window Sticker

08/02/2013	Ontario Ministry of Transportation	Registration issued or renewed - First owner reported - Registered as corporate fleet vehicle - Passed safety inspection - Vehicle color noted as Blue
06/10/2014 30,552	Active Green& Ross St. Catharines, ON 905-682-8352 activegreenross.com ★ 5.0 / 5.0 5 Verified Reviews ❤️ 10 Customer Favorites	 Vehicle serviced - Maintenance inspection completed - Oil and filter changed - Tire condition and pressure checked - Tire(s) balanced - Tires rotated - Odometer reported as 49,169 kilometers



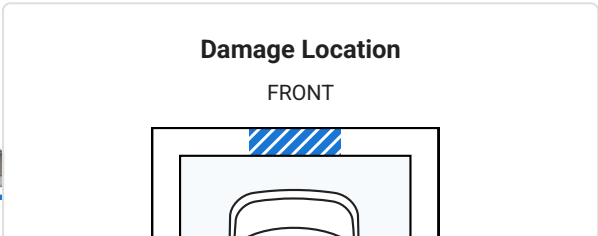
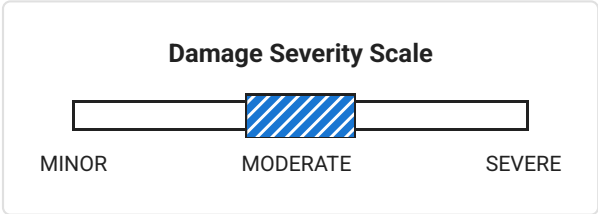

06/22/2014	Ontario Damage Report	 Accident reported: moderate damage - It hit an object - Damage to front
------------	--------------------------	--

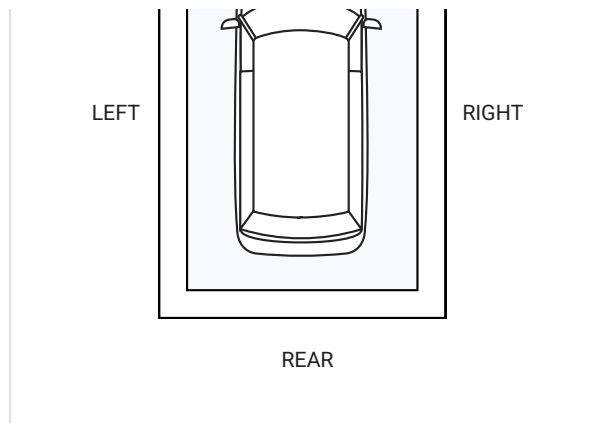

CARFAX HAS THE MOST







ACCIDENT & DAMAGE INFORMATION



08/25/2014 36,324	Raceway Chrysler Etobicoke, ON 416-743-9900 racewaychrysler.com  11 Customer Favorites	 Vehicle serviced - Odometer reported as 58,458 kilometers
01/01/2015	Ontario Ministry of Transportation	Registration issued or renewed - Registered as corporate fleet vehicle
07/15/2015 41,393	Ontario Ministry of Transportation	Passed Ontario safety standards inspection - Registration issued or renewed - New owner reported - Vehicle color noted as Blue - Odometer reported as 66,616 kilometers
08/11/2015 42,874	Ontario Ministry of Transportation	Odometer reading reported - Odometer reported as 68,999 kilometers
10/02/2015	Ontario Ministry of Transportation	Registration issued or renewed
10/28/2015 46,973	Southbank Dodge Chrysler Ottawa, ON 613-731-1970 southbankdodge.com  4.4 / 5.0 15 Verified Reviews  3 Customer Favorites	 Vehicle serviced - Brake calipers cleaned/serviced - Four tires balanced - Four tires mounted - Four tires replaced - Four wheel alignment performed - Front brakes serviced - Rear brakes serviced/adjusted - Tire(s) balanced - Tire(s) replaced - Odometer reported as 75,596 kilometers

KILOMETERS

05/24/2017	76,771	Boivin Automotive Repair Gloucester, ON 613-731-1502 2 Customer Favorites		Vehicle serviced
08/11/2017	81,336	Great Canadian Oil Change Ottawa, ON 613-733-7341 gcoc.ca 4.9 / 5.0 13 Verified Reviews		Vehicle serviced - Fluids checked - Oil and filter changed - Odometer reported as 130,898 kilometers
10/02/2017		Ontario Ministry of Transportation		Registration issued or renewed
10/12/2017	84,725	Great Canadian Oil Change Ottawa, ON 613-733-7341 gcoc.ca 4.9 / 5.0 13 Verified Reviews		Vehicle serviced - Fluids checked - Oil and filter changed - Odometer reported as 136,352 kilometers
11/07/2017	87,335	Boivin Automotive Repair Gloucester, ON 613-731-1502 2 Customer Favorites		Vehicle serviced - Tire(s) mounted
03/08/2018	92,800	Great Canadian Oil Change Nepean, ON 613-274-7999 gcoc.ca 4.2 / 5.0 18 Verified Reviews		Vehicle serviced - Fluids checked - Oil and filter changed - Odometer reported as 149,347 kilometers
05/10/2018	94,606	Boivin Automotive Repair Gloucester, ON 613-731-1502 2 Customer Favorites		Vehicle serviced - Rear brake pads replaced
07/07/2018	97,505	Great Canadian Oil Change Ottawa, ON 613-733-7341 gcoc.ca 4.9 / 5.0 13 Verified Reviews		Vehicle serviced - Fluids checked - Oil and filter changed - Odometer reported as 130,898 kilometers

07/27/2018	97,505	Great Canadian Oil Change Nepean, ON 613-274-7999 gcoc.ca ★ 4.2 / 5.0 18 Verified Reviews	 Vehicle serviced - Air filter checked - Fluids checked - Oil and filter changed - Odometer reported as 156,919 kilometers
08/31/2018		Boivin Automotive Repair Gloucester, ON 613-731-1502 ❤️ 2 Customer Favorites	 Vehicle serviced - Tire repaired
10/09/2018	102,324	Great Canadian Oil Change Nepean, ON 613-274-7999 gcoc.ca ★ 4.2 / 5.0 18 Verified Reviews	 Vehicle serviced - Antifreeze/coolant checked - Fluids checked - Oil and filter changed - Tire condition and pressure checked - Odometer reported as 164,675 kilometers
01/14/2019	105,785	Boivin Automotive Repair Gloucester, ON 613-731-1502 ❤️ 2 Customer Favorites	 Vehicle serviced - Front brake pads replaced - Front brake rotor(s) replaced - Oil and filter changed - Spark plug(s) replaced - Transmission filter replaced - Transmission fluid changed - Transmission fluid flushed
04/30/2019	111,580	Great Canadian Oil Change Nepean, ON 613-274-7999 gcoc.ca ★ 4.2 / 5.0 18 Verified Reviews	 Vehicle serviced - Fluids checked - Oil and filter changed - Tire condition and pressure checked - Odometer reported as 179,571 kilometers
02/28/2020	125,339	Boivin Automotive Repair Gloucester, ON 613-731-1502 ❤️ 2 Customer Favorites	 Vehicle serviced - Rear shock absorber(s) replaced
04/20/2020	126,520	Boivin Automotive Repair Gloucester, ON 613-731-1502	 Vehicle serviced - Fluids checked

 2 Customer Favorites

05/29/2020 127,163 Boivin Automotive Repair
Gloucester, ON
613-731-1502



Vehicle serviced

 2 Customer Favorites

09/16/2020 133,997 Boivin Automotive Repair
Gloucester, ON
613-731-1502



Vehicle serviced

 2 Customer Favorites

10/01/2020 135,099 Great Canadian Oil Change
Nepean, ON
613-274-7999
gcoc.ca
★ 4.2 / 5.0
18 Verified Reviews



Vehicle serviced

- Maintenance inspection completed
- Fluids checked
- Oil and filter changed
- Odometer reported as 217,421 kilometers

12/14/2020 138,941 Great Canadian Oil Change
Ottawa, ON
613-733-7341
gcoc.ca
★ 4.9 / 5.0
13 Verified Reviews



Vehicle serviced

- Maintenance inspection completed
- Air filter checked
- Fluids checked
- Oil and filter changed
- Odometer reported as 223,604 kilometers

08/25/2021 148,786 Boivin Automotive Repair
Gloucester, ON
613-731-1502
<https://facebook.com/boivinautomotiverepair/>
 2 Customer Favorites



Vehicle serviced

- Wheel bearing(s)/hub(s) replaced
- Odometer reported as 239,448 kilometers

11/23/2021 152,235 Ontario Ministry of Transportation

Registration issued or renewed

- Vehicle color noted as Blue
- Odometer reported as 244,998 kilometers

11/24/2021 154,080 Great Canadian Oil Change
Nepean, ON
613-274-7999



Vehicle serviced

- Maintenance inspection completed
- Fluids checked
- Oil and filter changed

gcoc.ca
 ★ 4.2 / 5.0
 18 Verified Reviews

Odometer reported as 247,968 kilometers

03/10/2022 157,543

Great Canadian Oil Change
 Ottawa, ON
 613-733-7341
 gcoc.ca
 ★ 4.9 / 5.0
 13 Verified Reviews



Vehicle serviced
 - Maintenance inspection completed
 - Air filter checked
 - Air filter replaced
 - Fluids checked
 - Oil and filter changed
 - Odometer reported as 253,541 kilometers

05/30/2022 159,085

Boivin Automotive Repair
 Gloucester, ON
 613-731-1502
<https://facebook.com/boivinautomotiverepair/>
 2 Customer Favorites



Vehicle serviced
 - Brakes serviced
 - Front brake pads replaced
 - Front brake rotor(s) replaced
 - Odometer reported as 256,022 kilometers

07/05/2023

Ontario Ministry of Transportation

Passed Ontario safety standards inspection
 - New owner reported
 - Vehicle color noted as Blue

07/24/2023 170,742

Donnelly Ford
 Ottawa, ON
 613-733-6931
<https://donnellyford.com/>
 ★ 3.9 / 5.0
 7 Verified Reviews
 8 Customer Favorites



Vehicle serviced
 - Tire repaired
 - Odometer reported as 274,783 kilometers

08/02/2023

Online Listing

Vehicle offered for sale

08/03/2023

Quebec Motor Vehicle Dept.

Registration issued or renewed
 - New owner reported
 - Vehicle previously registered in Ontario

08/21/2023 171,363

Quebec Motor Vehicle Dept.

Registration issued or renewed
 - New owner reported
 - Odometer reported as 275,782 kilometers

08/22/2023 88,856

Quebec Motor Vehicle Dept.

Registration issued or renewed
 Odometer reported as 143,000

- kilometers

MILEAGE INCONSISTENCY



The mileage reported here conflicts with this vehicle's odometer history. Ask a mechanic or the seller to confirm the actual mileage - this entry may just be a clerical error.

10/09/2023	Quebec Motor Vehicle Dept.	Registration issued or renewed
10/14/2024	Quebec Motor Vehicle Dept.	Registration issued or renewed
01/17/2025	Ontario Ministry of Transportation	Registration issued or renewed - New owner reported

Have Questions? Consumers, please visit our Help Center at www.carfax.com. Dealers or Subscribers, please visit our Help Center at www.carfaxonline.com.



Glossary

Accident Indicator

CARFAX receives information about accidents in all 50 states, the District of Columbia and Canada.

Not every accident is reported to CARFAX. As details about the accident become available, those additional details are added to the CARFAX Vehicle History Report. CARFAX recommends that you have this vehicle inspected by a qualified mechanic.

- According to the National Safety Council, Injury Facts, 2021 edition, 5% of the 276 million registered vehicles in the U.S. were involved in an accident in 2019. Over 77% of these were considered minor or moderate.
- This CARFAX Vehicle History Report is based only on information supplied to CARFAX and available as of 4/17/25 at 5:00:03 PM (CDT). Other information about this vehicle, including problems, may not have been reported to CARFAX. Use this report as one important tool, along with a vehicle inspection and test drive, to make a better decision about your next used car.

Damage Severity

Damage events result in one of the following severity levels:

- **Minor:** Generally, minor damage is cosmetic (including dents or scratches), may only require reconditioning, and typically does not compromise a vehicle's operation and/or safety.
- **Moderate:** Moderate damage may affect multiple components of the vehicle and may impair the vehicle's operation and/or safety.
- **Severe:** Severe damage usually affects multiple components of the vehicle and is likely to compromise the vehicle's operation and/or safety.

CARFAX recommends getting a pre-purchase inspection at a certified collision repair facility.

First Owner

When the first owner(s) obtains a title from a Department of Motor Vehicles as proof of ownership.

Fleet Vehicle

Vehicle was registered or sold to a company that manages vehicle fleets.

Mileage Inconsistency



If an odometer reading is less than a previous reading but CARFAX is uncertain whether the discrepancy is a rollback or a clerical error, then CARFAX calls it a "Mileage Inconsistency". In this case, you should verify the mileage with your dealer or a qualified mechanic.

New Owner Reported

When a vehicle is sold to a new owner, the Title must be transferred to the new owner(s) at a Department of Motor Vehicles.

Ownership History

CARFAX defines an owner as an individual or business that possesses and uses a vehicle. Not all title transactions represent changes in ownership. To provide estimated number of owners, CARFAX proprietary technology analyzes all the events in a vehicle history. Estimated ownership is available for vehicles manufactured after 1991 and titled solely in the US including Puerto Rico. Dealers sometimes opt to take ownership of a vehicle and are required to in the following states: Maine, Massachusetts, New Jersey, Ohio, Oklahoma, Pennsylvania and South Dakota. Please consider this as you review a vehicle's estimated ownership history.

Follow Us:  facebook.com/CARFAX  [@CARFAXinc](https://twitter.com/CARFAXinc)  [About CARFAX](#)

CARFAX DEPENDS ON ITS SOURCES FOR THE ACCURACY AND RELIABILITY OF ITS INFORMATION. THEREFORE, NO RESPONSIBILITY IS ASSUMED BY CARFAX OR ITS AGENTS FOR ERRORS OR OMISSIONS IN THIS REPORT. CARFAX FURTHER EXPRESSLY DISCLAIMS ALL WARRANTIES, EXPRESS OR IMPLIED, INCLUDING ANY IMPLIED WARRANTIES OF MERCHANTABILITY OR FITNESS FOR A PARTICULAR PURPOSE.

© 2025 CARFAX, Inc., part of S&P Global. All rights reserved.
4/17/25 5:00:03 PM (CDT)

I have reviewed and received a copy of the CARFAX Vehicle History Report for this 2014 CHRYSLER TOWN AND COUNTRY vehicle (VIN: 2C4RC1CGXER118258), which is based on information supplied to CARFAX and available as of 4/17/25 at 6:00 PM (EDT).

Customer Signature

Date

Dealer Signature

Date