



Vehicle History Report™

US \$44.99

2017 ACURA RDX W/TECH

VIN: 5J8TB4H5XHL804641
4 DOOR WAGON/SPORT
UTILITY
3.5L V6 F SOHC 24V
GASOLINE
ALL WHEEL DRIVE

Accident reported: severe damage

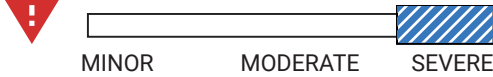

MINOR MODERATE SEVERE

 **12** Service history records

 **5** Previous owners

 Types of owners: Personal, Commercial

 **33,439** Last reported odometer reading



This CARFAX Vehicle History Report is based only on information supplied to CARFAX and available as of 7/19/24 at 2:41:31 PM (CDT). Other information about this vehicle, including problems, may not have been reported to CARFAX. Use this report as one important tool, along with a vehicle inspection and test drive, to make a better decision about your next used car.

Accident / Damage History

Not all accidents / issues are reported to CARFAX

Event 1

12/19/2021

Accident reported: severe damage

- Vehicle involved in a sideswipe collision with another motor vehicle

Damage Severity Scale

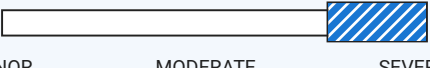

MINOR MODERATE SEVERE

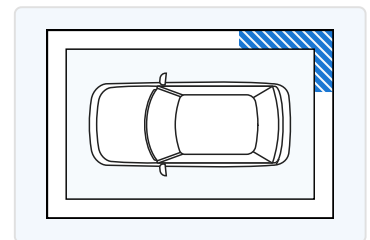



Event 2

12/19/2021

Damage claim reported

- Claim amount was CAD\$20,190
- Claim amount was updated on 03/05/2022.

 Additional History Not all accidents / issues are reported to CARFAX	Owners 1-3	Owner 4	Owner 5
Total Loss No total loss reported to CARFAX.	<input checked="" type="checkbox"/> No Issues Reported	<input checked="" type="checkbox"/> No Issues Reported	<input checked="" type="checkbox"/> No Issues Reported
Structural Damage CARFAX recommends that you have this vehicle inspected by a collision repair specialist.	<input checked="" type="checkbox"/> No Issues Reported	<input checked="" type="checkbox"/> No Issues Reported	<input checked="" type="checkbox"/> No Issues Reported
Airbag Deployment No airbag deployment reported to CARFAX.	<input checked="" type="checkbox"/> No Issues Reported	<input checked="" type="checkbox"/> No Issues Reported	<input checked="" type="checkbox"/> No Issues Reported
Odometer Check No indication of an odometer rollback.	<input checked="" type="checkbox"/> No Issues Indicated	<input checked="" type="checkbox"/> No Issues Indicated	<input checked="" type="checkbox"/> No Issues Indicated
Accident / Damage Accident reported: 12/19/2021.	Severe Damage	No New Issues Reported	No New Issues Reported
Manufacturer Recall No open recalls reported to CARFAX. Check with an authorized Acura dealer for any open recalls.	<input checked="" type="checkbox"/> No Recalls Reported	<input checked="" type="checkbox"/> No Recalls Reported	<input checked="" type="checkbox"/> No Recalls Reported

 Title History CARFAX guarantees the information in this section	Owners 1-3	Owner 4	Owner 5
Damage Brands Salvage Junk Rebuilt Fire Flood Hail Lemon	<input checked="" type="checkbox"/> Guaranteed No Problem	<input checked="" type="checkbox"/> Guaranteed No Problem	<input checked="" type="checkbox"/> Guaranteed No Problem
Odometer Brands Not Actual Mileage Exceeds Mechanical Limits	<input checked="" type="checkbox"/> Guaranteed No Problem	<input checked="" type="checkbox"/> Guaranteed No Problem	<input checked="" type="checkbox"/> Guaranteed No Problem



GUARANTEED - None of these title problems were reported by a U.S. state Department of Motor Vehicles (DMV). If you find that any of these title problems were reported by a DMV and not included in this report, you may qualify.
View Terms | View Certificate

 Ownership History The number of owners is estimated	Owners 1-3	Owner 4	Owner 5
Year purchased	2016	2022	2022
Type of owner	See Details	Personal	Personal
Estimated length of ownership	5 yrs. 4 mo.	4 months	1 yr. 2 mo.
Owned in the following states/provinces	See Details	Ontario	Ontario
Estimated miles driven per year	See Details	---	---

Last reported odometer reading

31,879

33,439



Detailed History





Owner 1

Purchased: 2016



Low mileage! This owner drove less than the industry average of 15,000 miles per year.

Personal Vehicle
4,045 mi/yr

Date	Mileage	Source	Comments
09/15/2016		Ontario Ministry of Transportation	Registration issued or renewed - First owner reported - Passed safety inspection - Vehicle color noted as Gray
07/03/2017	4,521	Ontario Ministry of Transportation	Registration issued or renewed - Registered as personal vehicle - Odometer reported as 7,276 kilometers
11/30/2017	5,668	Acura Downtown Toronto, ON 416-867-1577 https://acuradowntown.ca ★ 4.9 / 5.0 10 Verified Reviews	 Vehicle serviced - Recommended maintenance performed - Rear brakes replaced - Rear brake pads replaced - Vehicle washed/detailed - Tire condition and pressure checked - Tire(s) balanced - Tires rotated - Oil and filter changed - Odometer reported as 9,122 kilometers
01/19/2018		Acura Downtown Toronto, ON 416-867-1577 https://acuradowntown.ca ★ 4.9 / 5.0 10 Verified Reviews	 Vehicle serviced
12/06/2018	10,086	Acura Downtown Toronto, ON 416-867-1577 https://acuradowntown.ca ★ 4.9 / 5.0 10 Verified Reviews	 Vehicle serviced - Vehicle washed/detailed - Fluids checked - Steering/suspension checked - Tires rotated - Odometer reported as 16,232 kilometers
10/11/2019	12,424	Ontario	Registration issued or renewed - Registered as personal vehicle

Ministry of
Transportation

- Odometer reported as 19,994
kilometers



Owner 2
Purchased: 2020

Personal Vehicle

Date	Mileage	Source		Comments
09/16/2020		Ontario Ministry of Transportation		Passed Ontario safety standards inspection - New owner reported
09/18/2020	14,353	Terrace Ford Lincoln Burlington, ON 905-632-6252 terrace.dealerconnection.com/ ★ 5.0 / 5.0 5 Verified Reviews ♥ 2 Customer Favorites		Vehicle serviced - Pre-delivery inspection completed - Recommended maintenance performed - Vehicle washed/detailed - Oil and filter changed - Safety inspection performed - Windshield washer checked - Tire condition and pressure checked - Odometer reported as 23,099 kilometers
09/22/2020	14,408	Ontario Ministry of Transportation		Passed Ontario safety standards inspection - Registration issued or renewed - Registered as personal vehicle - Odometer reported as 23,187 kilometers
10/21/2020		Terrace Ford Lincoln Burlington, ON 905-632-6252 terrace.dealerconnection.com/ ★ 5.0 / 5.0 5 Verified Reviews ♥ 2 Customer Favorites		Vehicle serviced - Vehicle washed/detailed - Safety inspection performed - Rear wiper blade replaced



Owner 3
Purchased: 2020

Commercial
Vehicle

Date	Mileage	Source		Comments
10/21/2020		Ontario Ministry of Transportation		Passed Ontario safety standards inspection - New owner reported - Vehicle color noted as Gray
12/29/2020	16,998	Active Green & Ross Hamilton, ON 905-523-4323		Vehicle serviced - Tire(s) replaced

activegreenross.com/

★ 4.8 / 5.0

5 Verified Reviews

♥ 15 Customer Favorites

- Odometer reported as 27,356 kilometers

03/20/2021 19,804

Brantford Honda
Brantford, ON
855-314-9384
brantfordhonda.com



Vehicle serviced

- Maintenance inspection completed
- Vehicle washed/detailed
- Oil and filter changed
- Odometer reported as 31,871 kilometers

05/01/2021 21,241

Brantford Honda
Brantford, ON
855-314-9384
brantfordhonda.com



Vehicle serviced

- Alignment checked
- Vehicle washed/detailed
- Odometer reported as 34,184 kilometers

07/31/2021 25,412

Brantford Honda
Brantford, ON
855-314-9384
brantfordhonda.com



Vehicle serviced

- Maintenance inspection completed
- Vehicle washed/detailed
- Oil and filter changed
- Odometer reported as 40,897 kilometers

09/10/2021 27,831

Ontario
Ministry of
Transportation
Southwestern Ontario

Registration issued or renewed

- Registered as commercial vehicle
- Vehicle color noted as Gray
- Odometer reported as 44,790 kilometers

11/20/2021 31,879

Brantford Honda
Brantford, ON
855-314-9384
brantfordhonda.com



Vehicle serviced

- Vehicle washed/detailed
- Drive belts checked
- Oil and filter changed
- Tire condition and pressure checked
- Tires rotated
- Brakes serviced
- Brakes checked
- Odometer reported as 51,304 kilometers

12/19/2021

Ontario
Damage Report



Accident reported: severe damage

- Vehicle involved in a sideswipe collision with another motor vehicle
- Damage to right rear

Damage Severity Scale

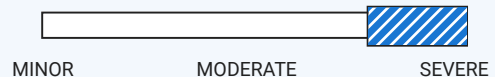

Damage Location

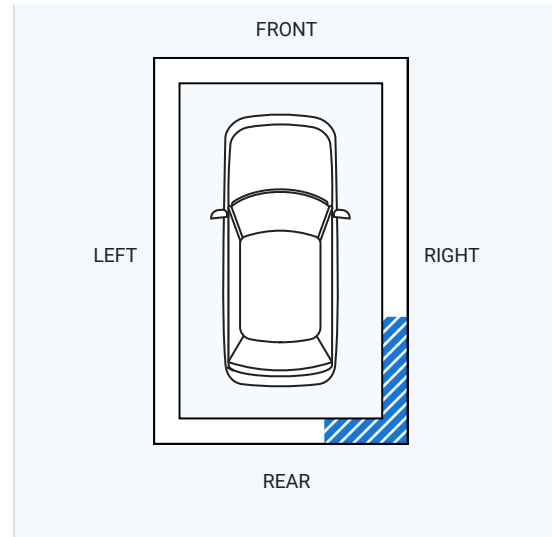

Safety first! In accidents like this, airbags may deploy and need replacing. Get them inspected before you buy. Airbag Tips

12/19/2021

Damage Report
Ontario



Damage claim reported

- Claim amount was CAD\$20,190
- Claim amount was updated on 03/05/2022.

 **Owner 4**
Purchased: 2022

Personal Vehicle

Date	Mileage	Source	Comments
02/07/2022		Ontario Ministry of Transportation	Requires Ontario safety standards inspection - New owner reported - Vehicle color noted as Gray

 **Owner 5**
Purchased: 2022

Personal Vehicle

Date	Mileage	Source	Comments
07/05/2022		Ontario Ministry of Transportation	Requires Ontario safety standards inspection - New owner reported - Vehicle color noted as Gray
09/20/2022	33,362	Wrench Auto Tech Inc Brampton, ON 905-497-2734 wrenchautotech.com/	 Vehicle serviced - A/C refrigerant recharged - Odometer reported as 53,691 kilometers

♥ 1 Customer Favorite

01/11/2023 33,439 Wrench Auto Tech Inc
Brampton, ON
905-497-2734
wrenchautotech.com/
♥ 1 Customer Favorite



Vehicle serviced

-Odometer reported as 53,815 kilometers

09/22/2023

Online Listing

Vehicle offered for sale

07/19/2024

CARFAX Car Care

Manufacturer Recommended Maintenance Schedules



Get this vehicle's maintenance schedule, service history and recall alerts at [carfax.com/service](https://www.carfax.com/service).

Have Questions? Please visit our Help Center at www.carfax.com.



Glossary

Accident Indicator

CARFAX receives information about accidents in all 50 states, the District of Columbia and Canada.

Not every accident is reported to CARFAX. As details about the accident become available, those additional details are added to the CARFAX Vehicle History Report. CARFAX recommends that you have this vehicle inspected by a qualified mechanic.

- According to the National Safety Council, Injury Facts, 2021 edition, 5% of the 276 million registered vehicles in the U.S. were involved in an accident in 2019. Over 77% of these were considered minor or moderate.
- This CARFAX Vehicle History Report is based only on information supplied to CARFAX and available as of 7/19/24 at 2:41:31 PM (CDT). Other information about this vehicle, including problems, may not have been reported to CARFAX. Use this report as one important tool, along with a vehicle inspection and test drive, to make a better decision about your next used car.

Canadian Damage Report

CARFAX receives damage reports for many accidents occurring in the following Canadian Provinces: Ontario, Alberta, Nova Scotia, New Brunswick, Prince Edward Island, Newfoundland, Yukon territories, Northwest territories, and Nunavut. These reports may be completed following an accident or other incident. Some include a damage claim amount. This amount represents physical damage to the vehicle and depending on the accident, damage to other vehicles and/or property. It does not include expenses like towing, a rental car or any medical related items.

Commercial

Vehicle was registered for business purposes.

Damage Indicator

Damage can be a result of many different types of events. Examples include contact with objects (other cars, trees, traffic signs, road debris, etc), vandalism, or weather-related events. Not every damage event is reported to CARFAX. As details about the damage event become available, those additional details are added to the CARFAX Vehicle History Report. CARFAX recommends that you have this vehicle inspected by a qualified mechanic.

- This CARFAX Vehicle History Report is based only on information supplied to CARFAX and available as of 7/19/24 at 2:41:31 PM (CDT). Other information about this vehicle, including problems, may not have been reported to CARFAX. Use this report as one important tool, along with a vehicle inspection and test drive, to make a better decision about your next used car.

Damage Severity

Damage events result in one of the following severity levels:

- **Minor:** Generally, minor damage is cosmetic (including dents or scratches), may only require reconditioning, and typically does not compromise a vehicle's operation and/or safety.
- **Moderate:** Moderate damage may affect multiple components of the vehicle and may impair the vehicle's operation and/or safety.
- **Severe:** Severe damage usually affects multiple components of the vehicle and is likely to compromise the vehicle's operation and/or safety.

CARFAX recommends getting a pre-purchase inspection at a certified collision repair facility.

First Owner

When the first owner(s) obtains a title from a Department of Motor Vehicles as proof of ownership.

New Owner Reported

When a vehicle is sold to a new owner, the Title must be transferred to the new owner(s) at a Department of Motor Vehicles.

Ownership History

CARFAX defines an owner as an individual or business that possesses and uses a vehicle. Not all title transactions represent changes in ownership. To provide estimated number of owners, CARFAX proprietary technology analyzes all the events in a vehicle history. Estimated ownership is available for vehicles manufactured after 1991 and titled solely in the US including Puerto Rico. Dealers sometimes opt to take ownership of a vehicle and are required to in the following states: Maine, Massachusetts, New Jersey, Ohio, Oklahoma, Pennsylvania and South Dakota. Please consider this as you review a vehicle's estimated ownership history.

Follow Us:  facebook.com/CARFAX  [@CARFAXinc](https://twitter.com/CARFAXinc)  **About CARFAX**

CARFAX DEPENDS ON ITS SOURCES FOR THE ACCURACY AND RELIABILITY OF ITS INFORMATION. THEREFORE, NO RESPONSIBILITY IS ASSUMED BY CARFAX OR ITS AGENTS FOR ERRORS OR OMISSIONS IN THIS REPORT. CARFAX FURTHER EXPRESSLY DISCLAIMS ALL WARRANTIES, EXPRESS OR IMPLIED, INCLUDING ANY IMPLIED WARRANTIES OF MERCHANTABILITY OR FITNESS FOR A PARTICULAR PURPOSE.

SYSTEMATIC RETRIEVAL OF THE CONTENT OR OTHER DATA FROM THIS SITE TO CREATE OR COMPILE, DIRECTLY OR INDIRECTLY, IN WHOLE OR IN PART, A COLLECTION, COMPILATION, DATABASE OR DIRECTORY WITHOUT THE EXPRESS WRITTEN PERMISSION OF CARFAX IS STRICTLY PROHIBITED. THE CARFAX VEHICLE HISTORY REPORT IS SUBJECT TO THE CARFAX.COM TERMS OF USE.

© 2024 CARFAX, Inc., part of S&P Global. All rights reserved.
7/19/24 2:41:31 PM (CDT)